

HYDRO-TURBINE BEARINGS & SEALS

OIL & GREASE FREE SOLUTIONS

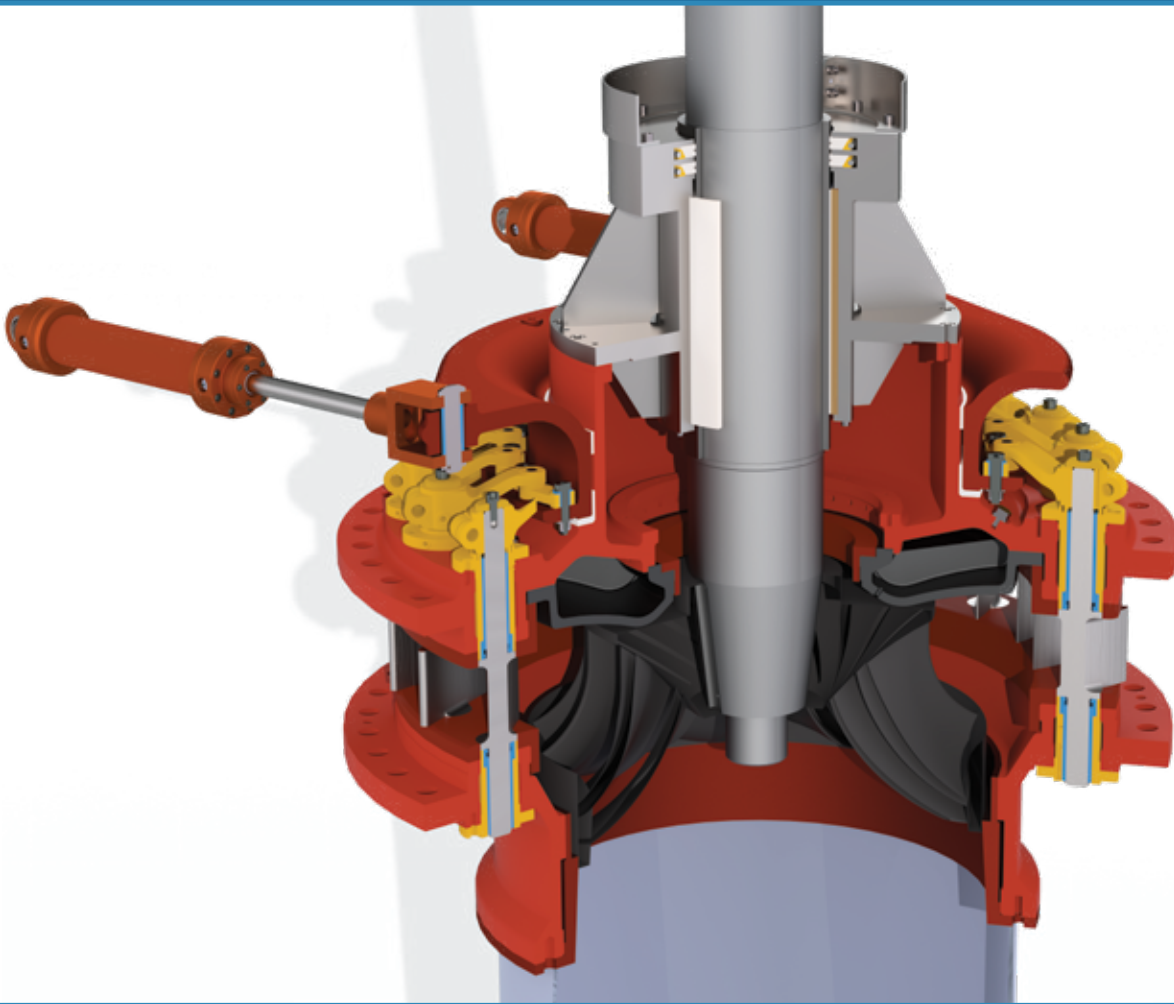

THORDON
THORDON BEARINGS INC.

ZERO POLLUTION | HIGH PERFORMANCE | BEARING & SEAL SYSTEMS

THORPLAS-BLUE

- ✓ Engineered thermoplastic for high pressure applications up to 45 MPa (6527 psi)
- ✓ Friction coefficient typically <0.10-0.15
- ✓ Full-form tubular configuration
- ✓ Very low wear
- ✓ Operates in water up to 80°C (176°F)



THORDON SXL

- ✓ Working pressure to 10 MPa (1450 psi)
- ✓ Friction coefficient typically 0.10-0.20
- ✓ Wet or dry operation
- ✓ High resistance to abrasion, shock loading and vibration
- ✓ Dry start-up capability



THORDON GM2401

- ✓ Made specifically for use in very abrasive water environments
- ✓ Stiffer and at least twice the abrasion resistance of rubber
- ✓ Lower friction coefficient than rubber

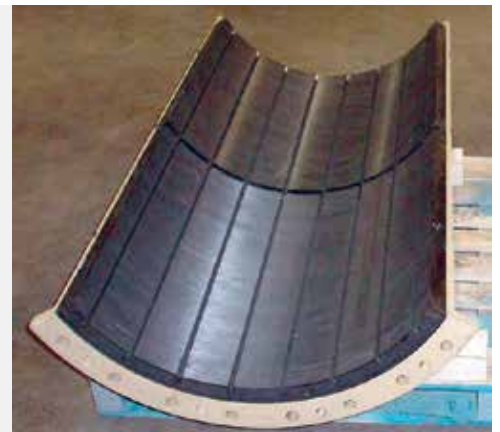

THORSEAL HYDRAULIC SEALS

- ✓ Keep abrasives from bearing surfaces
- ✓ Sealed Pressures from 0-100 MPa (0-15,000 psi)
- ✓ Tough – won't cut or tear
- ✓ Low friction – self-lubricating and suitable for use in oil or water
- ✓ Single & stacked for limited motion & reciprocating linear applications
- ✓ Can be custom designed to solve difficult sealing solutions

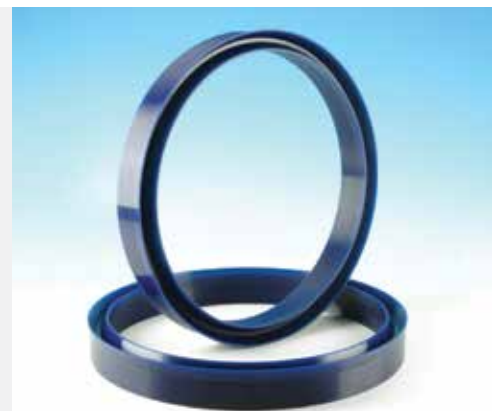

HIGH PERFORMANCE THAT OTHERS CAN'T MATCH

More than 40 years ago, Thordon developed an elastomeric polymer alloy that combined strength/stiffness with high toughness and abrasion resistance. We continue to innovate for the clean power generation industry and offer several different bearing grades and configurations to meet the demanding needs of your applications. The unique polymer structures for all grades are fully homogeneous so all the properties –self-lubrication, low coefficient of friction, abrasion resistance to vibration and shock loading – are consistent throughout the entire bearing wall thickness.

Our high performing products decrease life cycle costs, increase MTBF, and provide innovative designs that meet and exceed each customer's technical requirements. Thordon Bearings will reduce your environmental impact while improving overall performance by providing non-polluting bearing solutions for rehabilitation or new turbine projects.



We are very pleased with the performance of the Thordon Technology that was presented by Voith and we thought this was a good solution, not least for environmental reasons.

*Bjørnar Petersen,
Mechanical Engineer, Akershus Energy*



INNOVATIVE SOLUTIONS FOR HYDRO TURBINE REHABILITATION AND NEW PROJECTS

Thordon Bearings is a pioneer in producing high performance, long lasting bearing and seal system designs that require no oil or grease.

Our elastomer grades (SXL and GM2401) offer the best combination of strength and stiffness while maintaining flexibility and providing excellent abrasive wear resistance. The thermoplastic grade (ThorPlas-Blue) is a full form bearing or pad that can operate at higher pressures than Thordon elastomers. Regardless of grade or configuration, Thordon bearings do not require oil or grease lubrication in dry or wet conditions.

- ✓ Long wearlife and lower maintenance costs mean lower life-cycle costs
- ✓ Self-lubrication eliminates pollution risk
- ✓ Superior customer service means quick delivery and less downtime
- ✓ Full-cycle technical support includes system design, machining, installation and after-sales service
- ✓ Certification to ISO 9001 Quality System requirements ensures consistent high quality in both custom and stock solutions

Thousands of customers across the world, in both rehabilitation and new turbine projects, know Thordon Bearings is the proven choice for performance and value. Thordon bearings last.

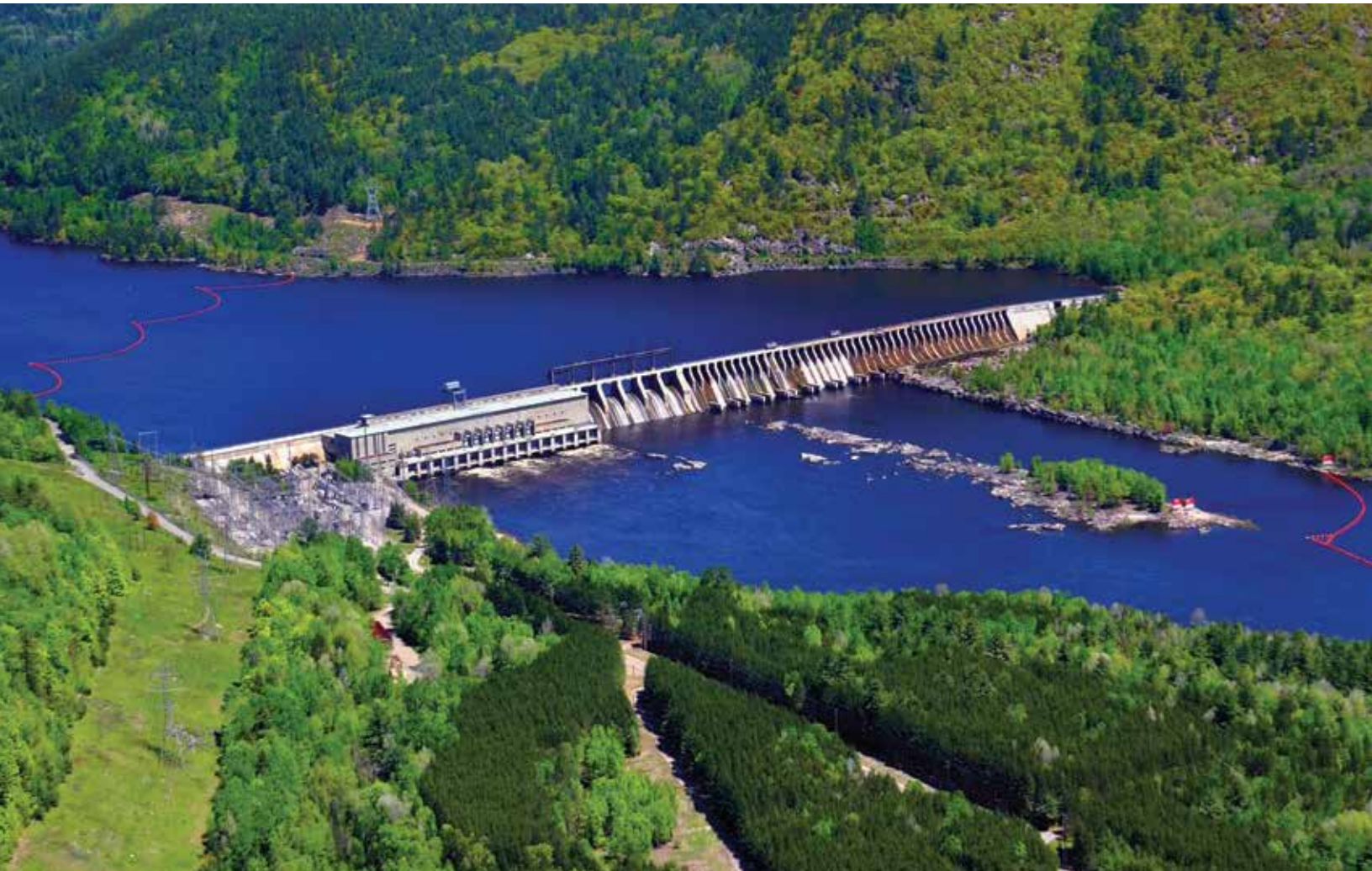

WICKET GATE AND OPERATING LINKAGE BEARINGS

Thordon wicket gate and linkage bearings operate wet or dry and eliminate the cost, maintenance and pollution risk associated with greased bearings.

Thordon offers the following benefits:

- ✓ Self-lubricating to ensure performance in limited-motion applications
- ✓ No galling from edge loading caused by misalignments or gate deflections
- ✓ Can be easily machined to final sizes on site, to accommodate older units that may have inconsistent housing sizes
- ✓ No stick slip if equipment is stationary for long periods of time
- ✓ Homogeneous product means uniformly distributed low friction lubricant through the full thickness of the bearing, without layers or limited depth working surfaces
- ✓ Quick stock and custom delivery to meet demanding rehabilitation schedules

Choose Grease-free ThorPlas-Blue for Wicket Gate and Operating Linkage Bearings.

ADDITIONAL PRODUCTS:

- Operating Ring Wear Pads
- Servomotor and Servo-Link Bearings
- Wicket Gate Thrust Bearings

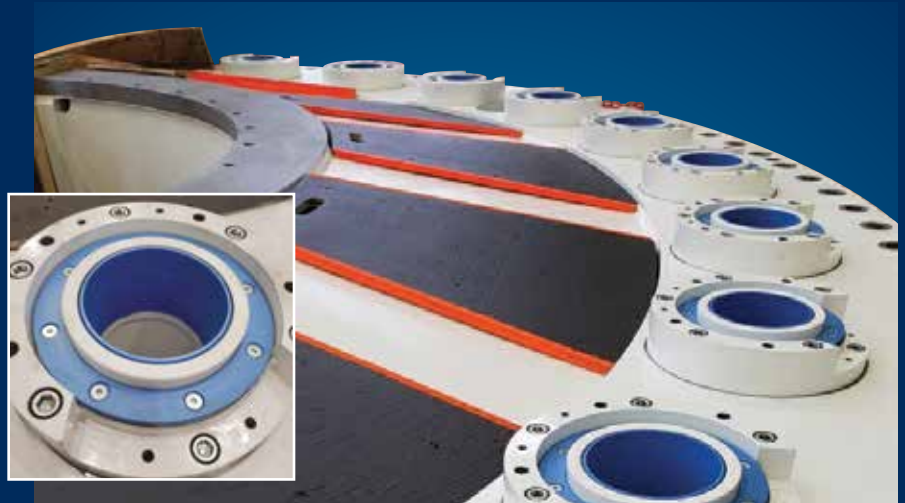

15 YEAR BEARING WEARLIFE GUARANTEE

Engineered to Perform. Built to Last.

ThorPlas-Blue Wicket Gate and Linkage Bearings' 15 Year Wearlife Guarantee demonstrates Thordon's confidence in ThorPlas-Blue bearings and the proven experience. Since the introduction of ThorPlas-Blue to the hydro-turbine market over 18 years ago, the excellent wearlife and low friction levels achieved worldwide, is significant.

Thordon guarantees that the diametric clearance of ThorPlas-Blue Wicket Gate & Linkage Bearings after 15 years in service will not exceed 5x the original installed clearance, or Thordon Bearings will supply new bearings free of charge.

For more information regarding eligibility and requirements to qualify for the 15 Year Guarantee, please visit:

www.ThordonBearings.com/WearLifeGuarantee





SXL
TURBINE GUIDE
BEARINGS WITH
TAPERED KEYSSET

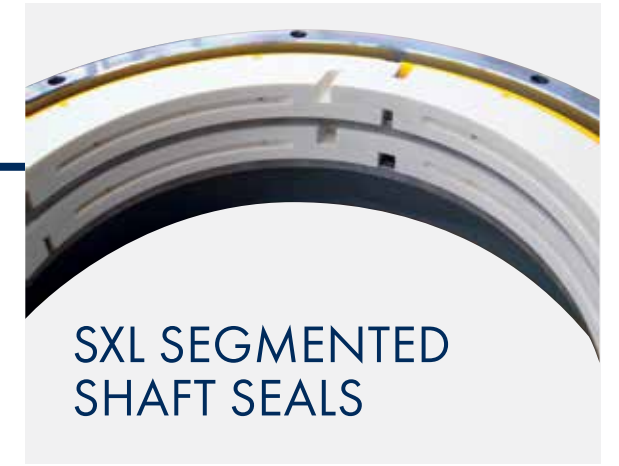
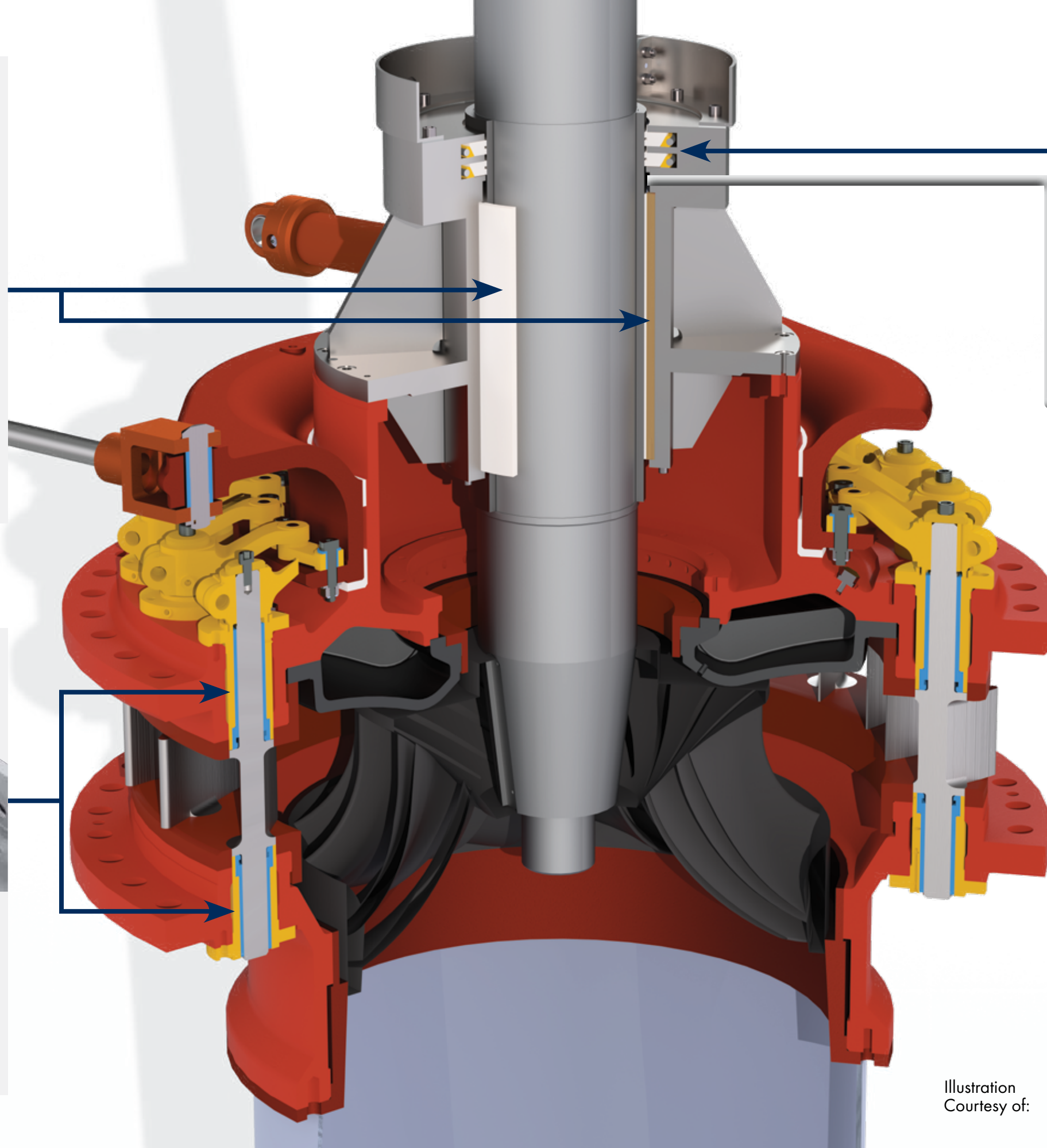

SXL SEGMENTED
SHAFT SEALS

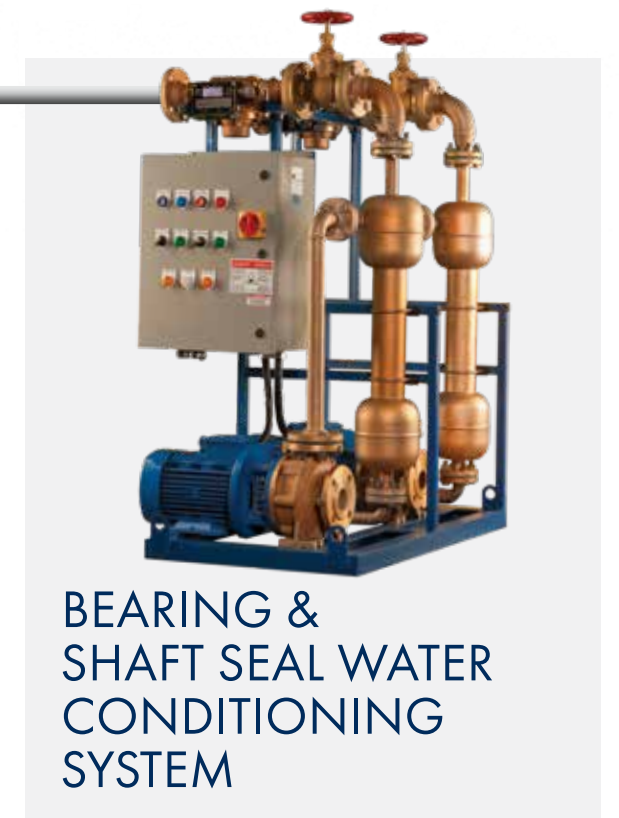

BEARING &
SHAFT SEAL WATER
CONDITIONING
SYSTEM



THORPLAS-BLUE
WICKET GATE/
LINKAGE/
OPERATING RING
BEARINGS

Illustration
Courtesy of:



SEGMENTED TURBINE SHAFT SEALS

Thordon SXL segmented axial and radial seals last longer and reduce life-cycle costs compared to carbon seals.

- ✓ Elastic material will not chip or crack during installation
- ✓ Reduced leakage by improving seal segment design and configuration
- ✓ Once carbon seal faces are replaced by SXL, sealing performance will improve
- ✓ High abrasion resistance of SXL material outlasts carbon seal faces in dirty river water
- ✓ Easy installation and high tolerance for axial and radial misalignment
- ✓ For extremely long seal life, recommended cooling water conditioning of 100 microns
- ✓ Can be installed as an upgrade to directly match & replace the carbon segment to fit the existing housing

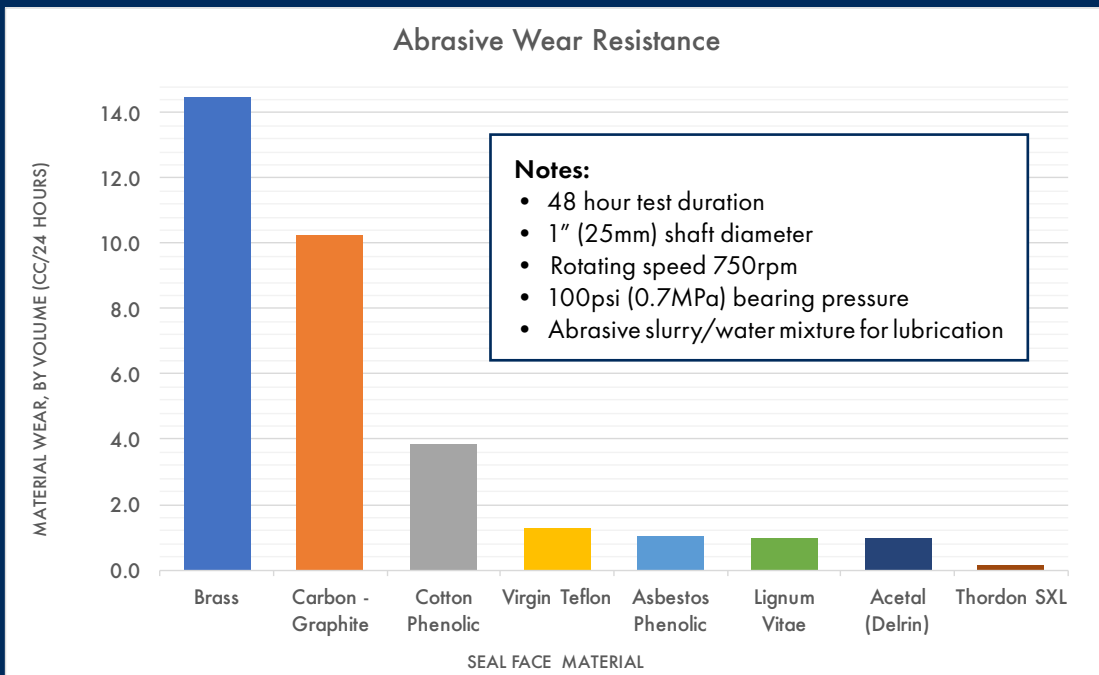

WATER CONDITIONING SYSTEMS

For any water-lubricated guide bearing, water flow is critical for flushing abrasives, cooling the bearing, and establishing a stable hydrodynamic fluid film to ensure long bearing life. Thordon Water Conditioning Systems are designed specifically to serve the requirements of Thordon guide bearings and shaft seals.

Thordon Water Conditioning Systems include the following features:

- ✓ Integrated monitoring and alarm on bearing water flow rate minimizes risk of bearing failure and to provide early warning of potential problems
- ✓ Conditioning to remove abrasive particles larger than 100 microns will maximize bearing life and provide consistent wear behavior
- ✓ PLC operation allows for extensive customization, remote operation, and full integration with turbine controls
- ✓ Available in Single or Duplex configurations for redundant back-up capability
- ✓ HMI Interface, adjustable pressure regulation, and additional options available
- ✓ Multiple flow capacity ranges available depending on requirement

TURBINE GUIDE BEARINGS

Thordon bearings are the best choice for your new turbine or upgrades from other bearing materials. Thordon's design capabilities and 40+ years of Hydro experience ensures that a fully engineered solution is always provided, rather than just supply of material to retrofit an existing water-lubricated guide bearing.

Thordon also offers engineering support from concept through to execution for full conversions from sealed oil systems to water-lubricated systems. Converting an oil bearing to water can help the operator to realize maintenance advantages from increasing accessibility of the shaft seal, environmental advantages by eliminating oil from close proximity to water, and potential performance advantages by enabling the guide bearing to be closer to the runner centerline.

Thordon engineered solutions will support your bearing design requirements. Complete package offerings can include Water Conditioning Systems, shaft seals and bearing condition monitoring packages.

THORDON RECOMMENDATIONS FOR TURBINE GUIDE BEARINGS

Water Lubrication	Recommended Thordon Grades	Notes
Clean/Conditioned Water	SXL with Thordon Water Conditioning System	Best suited in combination with Thordon's Water Conditioning System which provides conditioned water flow, giving predictable bearing wear and maximum bearing life.
With High Abrasive Content	GM2401 with hard shaft sleeve	The best dirty water bearing on the market with proven history in extremely abrasive environments with no water filtration required. Use of a hardened shaft sleeve ensures abrasives will not wear down the shaft surface.

Thordon homogeneous turbine guide bearings are easily installed into many different configurations:

- Tapered key design for fast and easy installation or removal
- Bonded/mechanically fastened into split or non-split bearing housings
- Full form cylindrical tubes
- Multiple pad-style arrangements for large diameter bearings >2.0m (6.5 ft.)
- Stave configurations available to directly replace worn out rubber, wood, or phenolic staves
- Other custom designed bearing solutions to fit any age or style of turbine

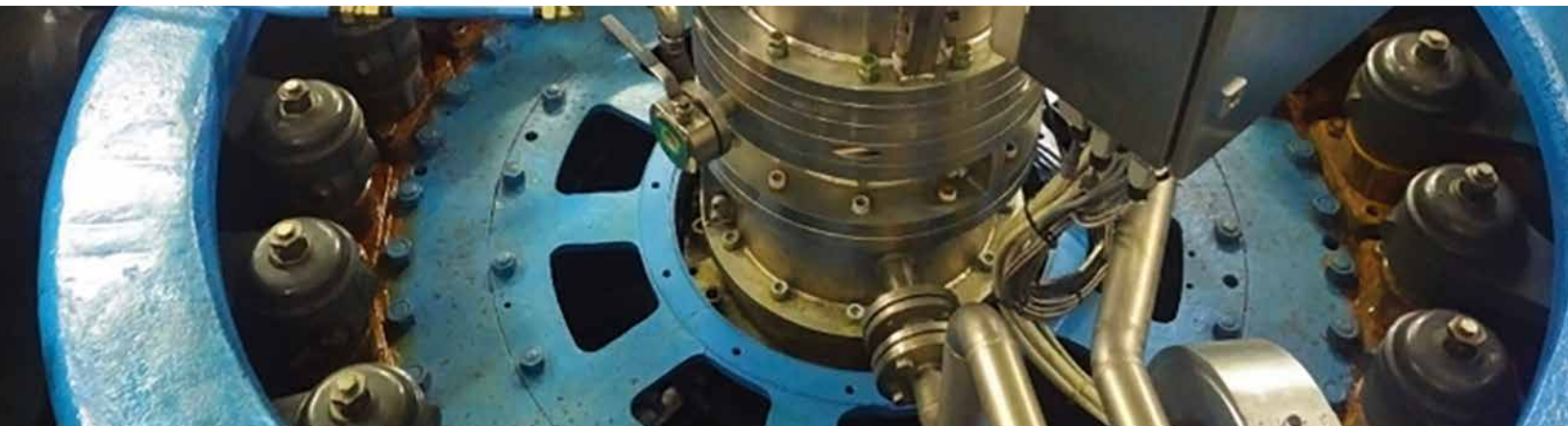

THORSEAL

Thorseals are made of a Thordon proprietary elastomer with no shelf life or degradation of properties over time. They are customized seals to be made for your specific application.

They are used in hard-to-reach wicket gate bearings to prevent contamination by abrasive laden waters or to seal water from entering the plant. They can also be integrated into ThorPlas-Blue bearing designs for easy one-piece installation.

In hydraulic/pneumatic applications, high performance, tough Thorseal self-lubricating polymer lip seals offer positive sealing up to 100 MPa (15,000 psi). Thorseals provide long wearlife with no need for periodic adjustments; resist tearing and extrusion; and as a result of their internal lubricants, operate with less drag and reduced cylinder wear.

Thorseal Applications include: Wicket Gate Seals / Kaplan Hub / Servo Motors / Turbine Brake Seals (cup or lip style) / Replacement for Rubber or Fabric Chevron or V-packing Seals.

- ✓ Keep abrasives from bearing surfaces
- ✓ Sealed Pressures from 0-100 MPa (0-15,000 psi)
- ✓ Tough - won't cut or tear
- ✓ Low friction – self-lubricating and suitable for use in oil or water
- ✓ Single & stacked for limited motion & reciprocating linear applications
- ✓ Can be custom designed to solve difficult sealing solutions



Thorseals are not only available in a wide range of standard sizes, but can also be quickly machined to custom size requirements up to 1.5 m (60") in diameter. With over 40 years of experience designing and optimizing sealing applications Thorseal is the right material for your application.

ZERO POLLUTION BEARING SYSTEMS

Thordon bearings help preserve the natural environments in which they operate. Our bearings and seals are pollution-free solutions.

Additional Applications for Thordon products:

- Main inlet valve seals and trunnion bearings (butterfly & spherical valves)
- Intake traveling screen bearings
- Stop log or head gate sliding wear pads
- Head gate roller wheel bearings
- Spherical linkage and servo-rod end bearings
- Grease-free gate hoist and winch bearings
- Pump bearings (dewatering pumps, station sump pump, etc.)
- Tainter gate & radial gate trunnion bearings
- Kaplan blade and cross head bearings



Ask us about proven Thordon solutions for many other Hydro applications as well!

THERE'S MORE TO THORDON BEARINGS THAN JUST POLLUTION-FREE SEALS & BEARINGS

Our experienced **Global Service & Support (GSS)** team can provide the following maintenance, installation and commissioning services:

TURBINE GUIDE BEARINGS

- ✓ Housing, bearing and liner measurements
- ✓ Thordon bearing and liner machining supervision
- ✓ Thordon bearing and liner installation
- ✓ Bearing service quality inspection
- ✓ Thordon bearing removal and re-installation (in-situ)
- ✓ Borescope inspection – bearings/liner/coating
- ✓ Water Conditioning System commissioning
- ✓ Oil-to-water conversion management
- ✓ Shaft alignment and measurement



WICKET GATE AND LINKAGE BEARINGS

- ✓ Housing, bearing and liner measurements
- ✓ Bearing and seal installation
- ✓ Bearing machining supervision
- ✓ Bearing installation



SHAFT SEALING SOLUTIONS

- ✓ SXL segmented shaft seal installation
- ✓ Maintenance
- ✓ Commissioning

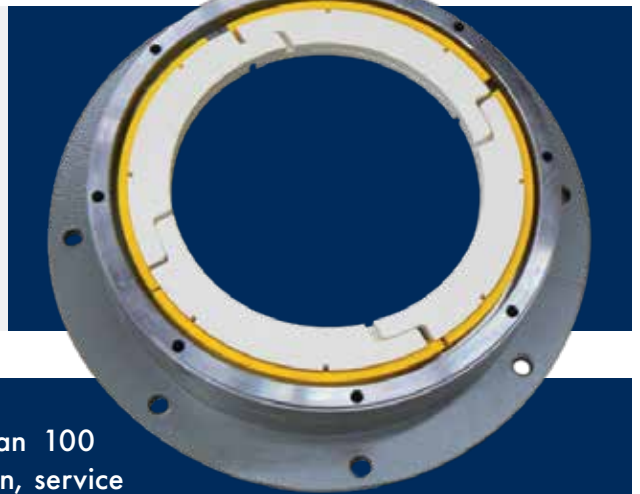

With a global service network operating 24/7 in more than 100 countries, Thordon Bearings' GSS team can install, commission, service and maintain the full range of Thordon Bearings' environmentally-safe products.

To find out more about Thordon Global Service & Support email: service@thordonbearings.com

CUSTOMER FOCUSED TO QUICKLY MEET YOUR NEEDS

Quick and Responsive Service

It takes quality products to be globally successful in the water-lubricated bearing and shaft seal industry. It also takes great service to keep customers coming back.

Thordon Bearings Inc. is geared to respond quickly to supply high performance bearing and seal solutions. Our products arrive quickly, fit right and last!

Extensive Distribution Network

Thordon Bearings has an extensive distribution network of more than 70 distributors in 100 countries to supply and service our global customer base. Non-standard requests are met with responsive design, quick machining and speedy delivery.

Application Engineering

Thordon engineers work closely with customers to provide innovative bearing and shaft seal system designs and solutions.

The Global Service and Support team can install, commission, service and maintain the full range of Thordon Bearings' environmentally-safe clean power generation products.

Manufacturing Quality

Thordon Bearings Inc. is a family-owned company with manufacturing and new product development facilities in Burlington, Ontario, Canada. In addition, we operate a leading edge manufacturing plant in Slupsk, Poland.

We manufacture to ISO 9001 Quality System requirements. Contact us for our installation references.

High Performance Bearings and Seals; Industry-Leading Service

Thordon Bearings is an industry leader in the design, manufacture, supply and installation of high performance, pollution-free, shaft bearing and seal systems.

Your Authorized Thordon Distributor

THORDON
THORDON BEARINGS INC.

3225 Mainway, Burlington, Ontario L7M 1A6 Canada

Tel: +1.905.335.1440 Fax: +1.905.335.4033 Email: info@thordonbearings.com Website: www.ThordonBearings.com



HTB 07/24
Printed in Canada