



Workboat operating on the Mississippi with Thordon TG100 Mechanical Face Seals.

## THORDON'S EMERGENCY INFLATABLE SEAL SYSTEM **PREVENTS SINKING** AFTER CATASTROPHIC SHAFT FAILURE

Activation of Thordon Bearings' revolutionary inflatable emergency seal prevented a 70ft (21m) long workboat from certain sinking in February, following multiple shaft failures that damaged the vessel's primary shaft seal.

*continued... 2*

### IN THIS ISSUE...

- 4 Navenor's Bearing Problems Solved with Thordon Retrofits
- 5 Alexis Marine to Retrofit RiverTough to Salt Lugger
- 6 Thordon ThorPlas-Blue Found to Reduce Operating Costs while Creating a Safer Working Environment
- 8 New Thordon Video Makes TG100 Seal Installation a Breeze
- 10 Thordon Systems Reduce Planned Maintenance Schedules for Offshore Vessel Operator
- 12 Thordon Gives New Class of Towboat Greater Life Expectancy
- 14 Thordon Bearings and Heddle Marine Team Up to Convert Ships to Pollution Free Propeller Shaft Lines

## THORDON'S **EMERGENCY INFLATABLE SEAL SYSTEM** PREVENTS SINKING *...continued*

The crew of the 2002-built twin-screw workboat activated Thordon Bearing's TG100's secondary seal during operations in the lower Mississippi River, when the vessel suffered catastrophic tailshaft failure in shallow waters north of New Orleans, Louisiana. The incident resulted in one of the tailshafts being pulled clear of the gearbox and almost completely out of the boat.

Jim Bright, Sales Manager, Thordon Bearings, said the situation was sudden and with no warning. "The starboard coupling bolts were sheared off, leaving the tailshaft with nowhere to go but out the back of the boat. Thankfully, the TG100 clamp ring prevented the shaft from being pulled any further back." Unlike

other shaft seal designs that are prone to slipping on the shaft, the TG100 wedge design increases its holding capability in a situation like this.

With the starboard shaft's primary TG100 seal heavily damaged and the vessel taking on water, the crew managed to activate the TG100's emergency secondary seal, which inflated as designed to re-seal the shaft.

The vessel was the very first workboat to be fitted with a TG100 seal in 2011.

"The primary seals performed flawlessly from the first day they went into service and we can now claim the same for the secondary emergency seal," said Bright.



*This TG100 seal prevented the vessel from sinking*



*A new TG100 seal was specified and installed*



*Jim Bright, Sales Manager on the US Inland Waterways*

Despite the calamity going on, the emergency seal functioned as it should, preventing further water ingress and allowing the crew to safely manage the damage. The safe-return-to-port function almost certainly prevented this vessel from sinking.

"Despite the calamity going on, the emergency seal functioned as it should, preventing further water ingress and allowing the crew to safely manage the damage. The safe-return-to-port function almost certainly prevented this vessel from sinking."

Following the incident, the owner, a large provider of marine transportation services in the U.S.A., with a fleet of more than 120 line-haul vessels, inland towing vessels, barges and tugs, needed to get the vessel back into service quickly. TG100 seals were once again specified.

The vessel was fitted with a prototype seal in 2011. "The incident was so violent we needed to replace the whole seal on the starboard side," said Bright. "The owner decided to also upgrade the portside shaft with the current TG100 seal."

The scope of supply also included the retrofitting of ThorPlas-Blue rudder and tiller bushings and Thordon RiverTough tailshaft bearings.

"The original rubber tailshaft bearings were found to be placing a tremendous amount of strain on shaft couplings due to very high wear rates, which could have been the root cause of the problem," said Bright.

Commenting on the success of the TG100 seal in the US market, Scott Groves, Thordon Bearings' Regional Manager - Americas, said: "The TG100 has an excellent performance record with hundreds of units now in service. It really is an important component to vessel safety, protecting not only the lives of the crew but also the vessel. The revolutionary design allows you to return safely to the nearest port if your primary seal is ever damaged. A number of Inland Towing companies have been replacing competitor products with the Thordon solution over the course of the past 12 months to reduce operational and maintenance costs," said Groves. "The TG100 seal requires no replacement parts over its service life." ☺

## NAVENOR'S **TAILSHAFT BEARING PROBLEMS SOLVED** WITH THORDON RETROFITS



Thordon Bearings has completed a range of water-lubricated and grease-free bearing installations to a third salt lugger in the Salinor/Navenor fleet, following the successful retrofitting of bearings to problematic newbuilds.

The Brazilian owner opted for the Thordon package following the rapid failure of the bronze and phenolic bearings supplied by a competitor to two newbuilds at the Manaus Shipyard delivered in 2015.

The salt carrier *Nossa Sra. das Das Victorias* was retrofitted with Thordon's SXL propeller shaft bearings after just three weeks of operation, while sistership *Dona Zita* was retrofitted with RiverTough shaft bearings and hardened steel liners in 2016.

José Fabio S. Camocardi, Managing Director, Thortech, Thordon Bearing's São Paulo-based distributor, takes up the story.

"Salinor/Navenor's dedicated carriers transport salt from mines located around the Northeast of Brazil area to discharge points offshore Brazil for loading on to larger ocean-going bulk carriers.

Because these vessels operate in both inland rivers and coastal seas, the blue water bearings and liners originally supplied were not suitable for operation in dirtier waters, especially those with a high sand and

silt content. They failed. We were contacted to find a solution, first for the *Nossa Sra. das Das Victorias* and, later, *Dona Zita*. The bearing retrofits have now provided trouble-free operation in all types of water in which these vessels operate."

Based on the success of Thordon installations, Navenor approached Thortech to supply a complete shaft and rudder bearing and seal package for the newbuild shallow draught bulker *Comandante Paschoal*.

Rio de Janeiro's São Miguel shipyard delivered the vessel in August 2018. The scope of supply comprised a pair of RiverTough propeller shaft bearings, NCB liners and three TG100 mechanical seals for shaft diameters of 135mm (5.3in), Thordon SXL rudder bearings for rudder shaft diameters of 168mm (6.6in), and grease-free ThorPlas-Blue bearings for the vessel's tiller arms and rudder stocks.

Scott Groves, Thordon's Regional Manager – Americas, said: "The customer had so many problems with the existing bearings supplied to the *Nossa Sra. das Das Victorias* and *Dona Zita* that a completely new approach was required for the São Miguel newbuilds. Following the earlier retrofit installations we were able to win the customer's confidence. In addition to the *Comandante Paschoal* installation, we have also been contracted to provide the full shaft line specification for a new salt carrier due for delivery next month. Thortech is also negotiating the supply of Thordon bearing solutions for a newbuild planned for 2019."

Salinor Salinas do Nordeste S.A. is Brazil's premier salt manufacturer, providing more than 40% of sea salt production in Brazil. Navenor, a Salinor company, is responsible for the transportation of Salinor's sea salt. 

## ALEXIS MARINE RETROFITS **RIVERTOUGH TAILSHAFT BEARINGS**

Louisiana-based workboat operator Alexis Marine has awarded a supply contract to Thordon Bearings for the retrofitting of 152mm (6in) diameter RiverTough bearings to *MV Kristin Alexis*, the 18.2m (60ft) twin-screw towboat built by Bollinger Shipyard in 1969.

Both the vessel's shafts were withdrawn at New Orleans yard Bayou Fabricators and Machine Works, where the original rubber bearings have been replaced with Thordon's RiverTough tailshaft bearings.

The polymer bearing manufacturer will also supply hard-wearing NiCrB sleeves to reduce the impact of operations in abrasive waters on the shafts.

Mike Alexis, CEO and founder, Alexis Marine, said: "It is not our first experience with RiverTough; the bearings have provided trouble-free operation for our fleet of tow/push boats for several years. We have had a very good experience with all of the installations.

"Due to the harsh waters in which these shallow draught vessels operate, we found that with the

original rubber bearings, we were drydocking once, sometimes twice a year. We have not had that problem with the Thordon system. Combined with the hard coated sleeves, there has been no sign of wear."

Scott Groves, Regional Manager - Americas, Thordon Bearings, added: "We are delighted that Alexis Marine has opted to retrofit RiverTough to the *MV Kristin Alexis*. The U.S. workboat sector is undoubtedly an important market for Thordon Bearings and an order like this from a returning customer is indicative of the commercial, operational and technical advantages our polymer bearings have over traditional rubber bearing types."

Jim Bright, Business Development Manager-USA, Thordon Bearings, added: "We expect the conversion will be a smooth process. Bayou has a lot of experience with Thordon products and has installed RiverTough to a number of workboats, as retrofit and newbuild solutions."

Alexis Marine operates its vessels as luggers on inland waterway, serving salt mines around Texas, Louisiana and the Yazoo-Mississippi delta. 



## THORDON **THORPLAS-BLUE** FOUND TO **REDUCE OPERATING COSTS** WHILE CREATING **A SAFER WORKING ENVIRONMENT**



*ThorPlas-Blue installed in tiller arm application*

The grease-free ThorPlas-Blue bearings Thordon supplied and installed to a Mississippi River line haul boat recently have helped reduce the vessel's operating costs while creating a safer working environment for the crew

When this 54.9m (180ft) triple screw work boat recently docked for repairs, the ThorPlas-Blue bearings previously retrofitted to the vessel's tiller and jockey bars by precision field machining company Mactech On-Site showed no signs of wear, despite two years of operating on the Mississippi River in the U.S.A.

In response to the customer's request for grease and corrosion-free tiller linkage capable of withstanding greater vertical movement of tiller pins, Thordon's grease-free ThorPlas-Blue bearings were retrofitted

to the triple screw towboat in 2016 with Mactech replacing the bronze bushings in the vessel's steering. Thordon Bearings' Business Development Manager - USA, Jason Perry, stated: "It is typical of these Mississippi workhorses to drydock frequently to replace their greased sleeve type bushings. These types of bearings are unable to tolerate angular misalignments resulting from deflection or improper mounting, which can place considerable stresses on the steering system, causing high levels of vibration, corrosion and, in some cases, pollution."

"The nature of the work done by these vessels and the environments in which they operate also means that metal-on-metal bearings are more susceptible to damage and rapid rates of wear, which can increase operational costs."

At various times during the past two years' the vessel's steering gear was spot checked by pulling the tiller pins and measuring the internal diameter of the bushings. Based on measurements taken by Mactech and the customer, the bearings had experienced "no measurable wear."

"The commercial benefits of no longer having to replace metal-on-metal bearings every one or two years or purchase, store and apply lubricating greases are obvious, but the crew has also remarked that the tiller flat is a cleaner, safer working environment. The linkage system is completely grease-free, so there's no chance of slipping on greasy decks."

Based on the results and performance of the Thordon bearings on this vessel, the customer has now opted to retrofit ThorPlas-Blue to ten additional workboats.

Commenting on the retrofit process, Mactech Operations Manager Monty Glisson explained: "To create a completely grease-free steering system, a ThorPlas retrofit typically involves replacing hydraulic power units and cylinders, and carrying out quadrant

modifications, as well as machining all quadrant and jockey bar bushings. Thordon and Mactech have the proper tools, experience, and processes to complete the job without removing all the steering components. We have a complete understanding of what the customer is trying to accomplish."

Prior to any retrofit project, Thordon and its partners will measure and record all as-found bushing data before creating a mock-up steering linkage. After this, new bushings are machined to size and clearance before fitting to quadrants and jockey bars. New wear plates are then manufactured for each pin joint and the steering system is reassembled with new pin retainers.

"The ease of machining allows the bushings to be finished quickly so that repairs and retrofits can be completed on time and without costly drydocking," said Glisson.

ThorPlas-Blue is a homogeneous, self-lubricating polymer bearing with a low dry coefficient of friction, high strength, and low creep. 



**NEW THORDON VIDEO  
MAKES TG 100 SEAL  
INSTALLATION A BREEZE**



Thordon Bearings has updated its TG100 seal installation requirements to facilitate cost-effective installation at all shipyards with the release of new instructional videos. Shipyard staff can quickly and easily install the state-of-the-art seal themselves, reducing the overall costs of TG100 procurement.

Craig Carter, Thordon Bearings' Director of Marketing and Customer Service, said: "Based on our experience at several shipyards in both North and South America from the more than 150 TG100 seal installations to date, the feedback from our customers is that installation of a TG100 seal is so straightforward that the need for specialist seal technicians is unnecessary."

In addition to instructions detailed in its TG100 Installation & Operation Manual, Thordon has produced a three-minute YouTube video outlining the steps shipyards need to take to achieve the perfect TG100 install. Additionally, a video has also been produced to guide shipyards through the ten-step process to prepare the TG100 seal for shaft withdrawal.

To ensure that installation remains under warranty, a simple registration form must be completed by either the shipyard or the vessel owner.

Jason Perry, Thordon Bearings' Business Development Manager – USA, said: "Of course, a Thordon Global Service and Support (GSS) specialist can still be appointed to oversee the installation, but the ability to easily install the seals themselves is a real benefit for those shipyards looking to reduce the overall cost of a TG100 seal installation. We hope this initiative will result in renewed market growth for the revolutionary seal. If you can read a tape measure and change a tire, you can install a TG100!"

With hundreds of TG100s in service, the state-of-the-art seal incorporates an important safety component allowing vessels to return safely to the nearest port should the primary seal undertake heavy damage.



**THORDON**  
TG100 Installation and Withdrawal  
videos can be viewed at:  
[www.youtube.com/ThordonBearings](http://www.youtube.com/ThordonBearings)

**TAKE THE WORK OUT OF WORKBOAT**  
Keep your boat in the water with **RiverTough** Tailshaft Bearings

- Easiest bearings to machine and install on the Mississippi
- Superior wearlife in abrasive marine environments
- Large stock availability at our two strategically located US Warehouses for fast delivery



**RiverTough**  
Tailshaft Bearings

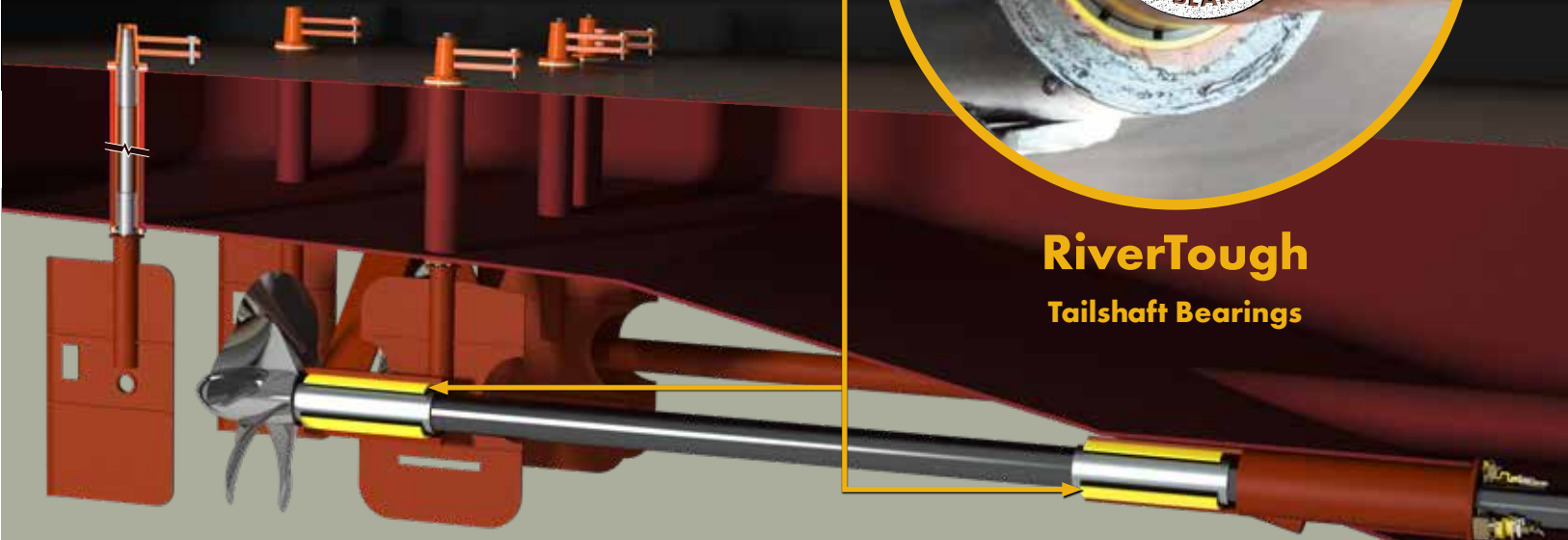

Contact Thordon's reliable and knowledgeable US Inland Waterways team for a quote today!  
*"We work hard so that you don't have to."*



**Kasey Cummings**  
270-493-0482  
kaseyc@thordonbearings.com



MISSISSIPPI AND OHIO RIVERS

**Jason Perry**  
502-612-9051  
jasonp@thordonbearings.com



GULF COAST

**Jim Bright**  
228-235-6495  
jimb@thordonbearings.com

ZERO POLLUTION | HIGH PERFORMANCE | BEARING & SEAL SYSTEMS

**THORDON**  
[www.ThordonBearings.com](http://www.ThordonBearings.com)

## THORDON SYSTEMS **REDUCE PLANNED MAINTENANCE SCHEDULES** FOR OFFSHORE VESSEL OPERATOR



TG100 seal after 3.5 years of stellar service on the *Global Tiger*

Thordon Bearings has notched up another success story for a customer in the demanding offshore sector, with a bearing and seal installation in “perfect condition” after over three years of operation.

*Global Tiger*, operated by UAE-based Global Marine Co is a 42m (138ft) crew/supply vessel currently in service in the Middle East. It is one of a pair of all-aluminum crewboats built by Grandweld of Dubai in 2015/2016. The vessel, with 83-person capacity, is powered by a triple-screw Caterpillar propulsion plant, each engine rated at 1450bhp, to give a maximum speed of 26 knots.

Since the vessel was intended for operation in the Middle East, with few shipyards offering full facilities for replacing stern gear seals and bearings, Global Marine was looking for a low-maintenance solution. Previous experience with gland packing had highlighted the need for regular tightening and re-packing, along with wear to the shaft in the packing area.

The customer discussed alternative seals and bearings with Thordon, through its distributor Ocean Power International (OPI) of Dubai, and decided to use Thordon’s SXL propeller shaft bearings with TG100 seals. Global Marine and OPI worked with builder Grandweld to ensure that the design of the vessel was optimised for the Thordon products. The ship designers modified the original design in accordance with Thordon’s recommended minimum length for seal installation. *Global Tiger* was delivered in 2016 with SXL bearings and TG100 seals on each of the three 114.3mm (4.5in) A22 Aqualloy Aquamet stainless steel shafts.

After three years of operation, Thordon’s engineers inspected the seals and bearings during a routine docking, and found no sign of wear, with the seals in perfect condition.

Shahram Nazemi of Global Marine highlighted the unrivalled performance of the Thordon products. “This is the first time we had decided to go with seals instead of gland packing,” he said. “Previously, we had to change spare parts at every dry docking. Following our instruction to the shipbuilder to incorporate Thordon TG100 seals in *Global Tiger*, we are delighted to state that after three years of service, the seals and bearings were found to be in perfect condition and the vessel was able to resume sailing with no maintenance whatever to the stern gear.”

“...we are delighted to state that after three years of service, the seals and bearings were found to be in perfect condition and the vessel was able to resume sailing with no maintenance whatever to the stern gear.”

Rafid Qureshi, Managing Director of Ocean Power International, said: “The SXL and TG100 are truly maintenance free alternatives to gland packing. We are pleased to report that the customer is highly satisfied with the performance of Thordon’s seals and bearings on *Global Tiger*.

“We were able to work with the shipbuilder to modify the design, ensuring that there was sufficient space for the seals, in both horizontal and vertical directions, and we advised that the customer fit a suitable flow meter to monitor flow of water lubricant in order to ensure smooth operation of the seals and give advance warning of any blockage in the system.”

Nazemi concluded: “We appreciate the quality of the Thordon seals and bearings, and the excellent service received from the company and its distributor. We will look to specify the TG100 in our planned newbuilds.”



## THORDON GIVES NEW CLASS OF TOWBOAT GREATER LIFE EXPECTANCY



The Tom Toretti fitted with RiverTough Tailshaft & SXL Rudder bearings, TG100 Seals and ThorPlas-Blue Linkage bearings.

### Thordon Bearings has received an order to supply four comprehensive shipsets of stern gear for a new class of towboat.

The four boats are being built by US shipyard Master Marine of Bayou La Batre, Alabama, for Waterfront Services, based in of Cairo, Illinois. The new vessels have been designed to meet the requirements of Subchapter M, a set of federal rules recently introduced by the US Coast Guard, relating to the inspection requirement for towboats, including seaworthiness standards and safety protocols.

These 67ft x 28ft boats, each powered by twin S6R2-Y3MPTAW Mitsubishi diesel engines, rated at 803hp at 1,400rpm, will drive 1778mm x 1219mm x 177mm (70in x 48in x 7in) 4-blade, stainless-steel propellers through Twin Disc MG 5321 gearboxes with 5:1 reduction ratio.

Thordon has been contracted to supply its RiverTough propeller shaft bearings for a 152mm (6in) diameter shaft, along with hardened shaft sleeves, SXL bearings for main and flanking rudders, TG100 tailshaft seals, and ThorPlas Blue steering linkage bushings.

"These are fleet boats, operating virtually 24/7 on the Mississippi River," explained Jim Bright, Thordon's USA Business Development Manager.

"They are operating in very abrasive water conditions, frequently running close to the river banks in shallow depths. The customer has previous experience of Thordon products, with some boats having clocked up 60,000 to 70,000 hours of trouble-free operation."

Steven Authement, from the sales and business development team at Master Marine, said that the decision to specify Thordon stern gear was made by the customer, based on the good performance of the company's products on other vessels. "Master Marine is very happy to be teaming up with Waterfront Services to provide these latest fleet boats with the best heavy-duty equipment available that's capable of meeting Subchapter M requirements," he added.

The first two vessels in the series, *Miss Deborah* and *Tom Toretti*, have already been handed over, in October 2017 and January 2018, respectively. The remaining two, *Sam P. Hise* and *Rick Pemberton* were scheduled for delivery in April and July 2018.

Thordon's RiverTough water-lubricated bearings were developed specifically for use in abrasive-laden dirty water such as that found in the Mississippi River system. When used in combination with hard-coated nickel-chrome-boron (NiCrB) shaft sleeves the arrangement can last twice as long as the rubber bearings.

The TG100 tailshaft seal uses high-quality, hard wearing silicon carbide faces and Thordon's proprietary elastomeric polymers to offer the optimum combination of strength/stiffness and flexibility/elasticity. The seal requires no routine maintenance, and although designed for abrasive conditions, it is equally at home in clean water.

"These new Waterfront vessels have the complete Thordon workboat package," said Bright. "The scope of supply includes SXL rudder bearings and ThorPlas-Blue steering linkage bushings. SXL has excellent friction resistance, with operating pressures up to 12 N/mm<sup>2</sup> (1740 psi).

These bearings can also withstand the high shock loads and edge loading typical of tow-boat operations. And what's more, like the ThorPlas-Blue bearings, completely eliminate the need for grease and greasing systems, removing any risk of pollution."

ThorPlas-Blue bearings, designed for a life-time of grease-free lubrication, are typically specified to replace the greased bronze bearings in virtually all steering and deck machinery applications. Since these bearings require no maintenance, the commercial advantages are obvious.

"Thordon's range of river towboat systems offers outstanding wearlife in abrasive waters. Any extra up-front cost is quickly offset by longer wearlife and reduced maintenance downtime over the life of the vessel," said Bright. 



## THORDON BEARINGS AND HEDDLE MARINE TEAM UP TO CONVERT SHIPS TO **POLLUTION FREE** PROPELLER SHAFT LINES



*Heddle Marine President, Shaun Padulo (left) and Thordon President & CEO Terry McGowan (right)*

Thordon Bearings Inc. and Heddle Marine Service Inc. signed a cooperative agreement under which the Canada-based ship repair company will work together with Thordon Bearings Inc. to promote the conversion of ships' oil lubricated propeller shafts to Thordon's COMPAC open seawater lubricated bearing system.

The agreement will create an action plan in which a specialist team, comprised of Heddle Marine and Thordon Bearings' personnel, to offer support to ship managers and owners looking to ensure their vessels are fully compliant with environmental legislation prohibiting the discharge of oil from the oil-to-sea interface of ships' propeller shafts. Shipowners could

face substantial financial penalties if their vessels are found to be noncompliant.

Shaun Padulo, President of Heddle Marine said: "Thordon Bearings is a pioneer in water lubricated propeller shaft bearings, with over 40 years' of experience in this technology. By entering into this partnership, we will not only have an opportunity to expand our service offering from a local supplier, but will also have the opportunity to provide our customers with a real, long-term solution to the environmental problems they face with oil lubricated stern tube bearings and seals. With concerns increasingly being raised about the impact of pollution from ships on the marine

environment, converting an oil lubricated system to seawater is the only guaranteed solution for today and tomorrow."

Terry McGowan, President and CEO of Thordon Bearings said: "Heddle Marine is one of Canada's leading shipyards with the capabilities and facilities required to carry out specialized ship repair, maintenance and conversion projects. And they have recently expanded to support the Great Lakes and eastern Canada."

Leaking shaft seals are known to be a significant contributor to on-going pollution at sea. The use of biodegradable lubricants, which are an improvement over mineral oils, are still an extremely expensive option for shipowners and some are having seal compatibility issues. Even biodegradable lubricants still need to be reported to authorities when discharges occur. Thordon provides a solution that uses seawater as the lubricant that meets all regulations, eliminating any risk of oil pollution.

"Seawater lubricated propeller shaft bearing systems are less complicated and time-consuming

to install than oil lubricated systems, providing clear commercial advantages for Heddle Marine and its customers," said McGowan. "There are fewer components, fewer pipe-runs, and no oil is required with a seawater lubricated system. Additionally, with recent class society rule changes, seawater lubricated propeller shaft bearing systems no longer have pre-determined shaft withdrawals as long as certain monitoring conditions are met."

He added: "This new partnership agreement provides a win-win situation for both parties. Heddle Marine will stand to benefit from having new customers and a new revenue stream with oil-to-water conversions, while Thordon Bearings will benefit from supplying the COMPAC seawater lubricated bearing equipment for upcoming conversion projects."

Under the terms of the agreement, Thordon Bearings will also provide equipment, training and guidance to Heddle Marine personnel and support the yard in carrying out propeller shaft conversion projects to the "highest standards and in the most efficient and cost effective manner." 

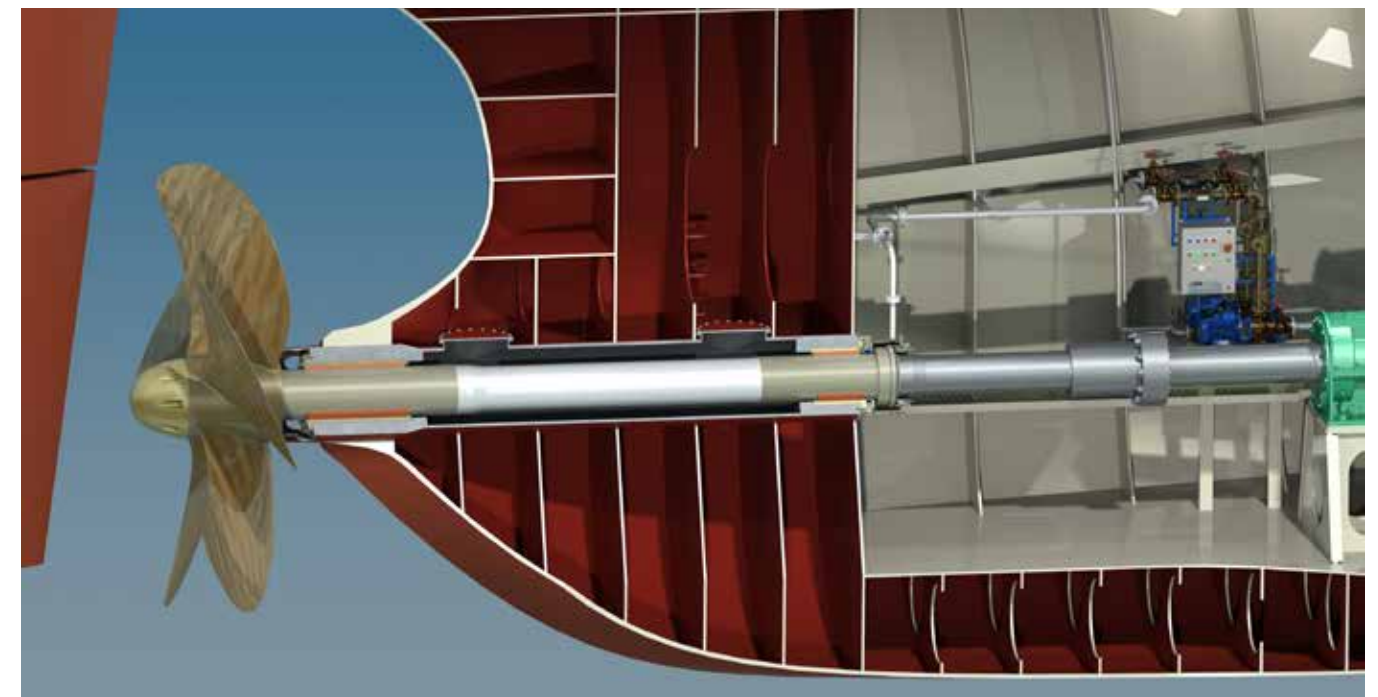



# TAKE THE **WORK** OUT OF **WORKBOAT**

Keep your boat in the water with Thordon's **TG100 Shaft Seal**

- Emergency seal offers safe return to port capability
- No expensive maintenance overhaul
- No wear on the shaft or liner
- No spare parts required
- Large stock availability at our two strategically located US Warehouses for fast delivery



**TG100**  
Shaft Seal



Contact our US Inland Waterways team today!

Mississippi & Ohio Rivers: 270-493-0482 | Gulf Coast: 228-235-6495

Published by:

# THORDON

THORDON BEARINGS INC.

*A Thomson-Gordon Group Company - Innovating since 1911*

3225 Mainway, Burlington, Ontario L7M 1A6 Canada

Tel: +1.905.335.1440 Fax: +1.905.335.4033

info@thordonbearings.com www.ThordonBearings.com

Printed in Canada | November 2019

**Editor:** Emma Gerard

*(Statements made and opinions expressed do not necessarily reflect those of the publishers)*

### Subscriber Information:

Wish to subscribe to our **NEWSWORKS** via e-mail or regular mail, or if your information has changed please contact our Marketing Department: [marketing@thordonbearings.com](mailto:marketing@thordonbearings.com)